

REV.	ECN.NO.	MODIFY.CONTENT	DATE
A		FIRST VERSION	12/04' 19

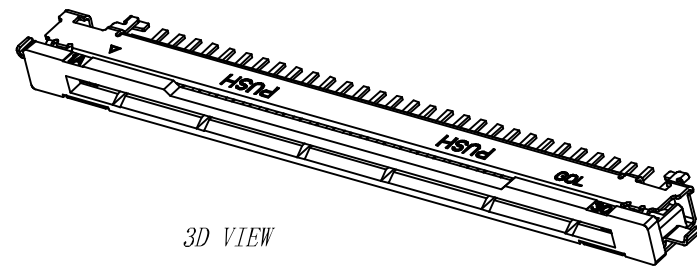

3D VIEW

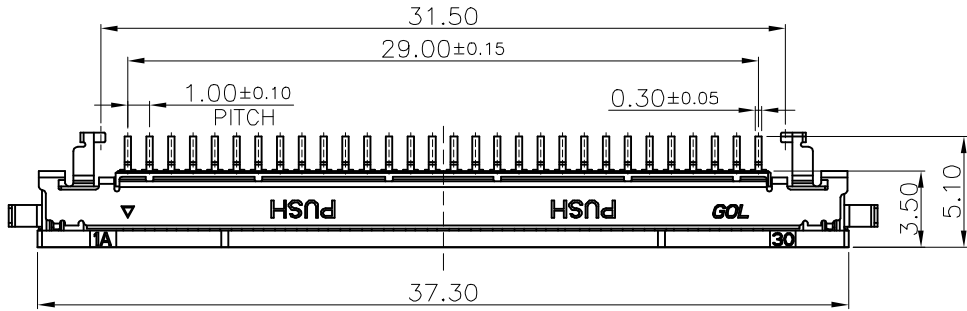
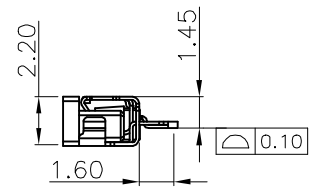
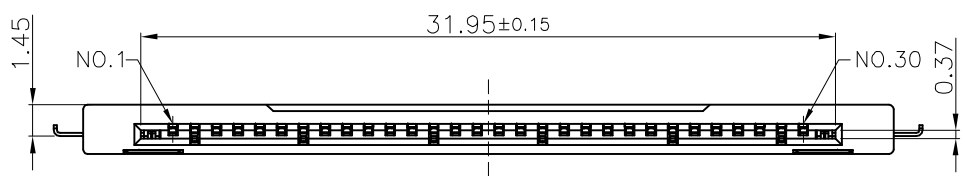

NOTES:
 Insulator: LCP , UL 94V-0
 Shell: STAINLESS STEEL/Tin-Plated
 Terminal: PHOSPHOR COPPER/Au-Plated
 Current Rating: 0.5A AC,DC
 Voltage Rating: 50V AC,DC
 Temperature range: -40°C~+85°C
 Contact resistance: 60mΩ Max
 Insulation resistance: 100MΩ Min
 Withstand voltage: 250V,AC/minute

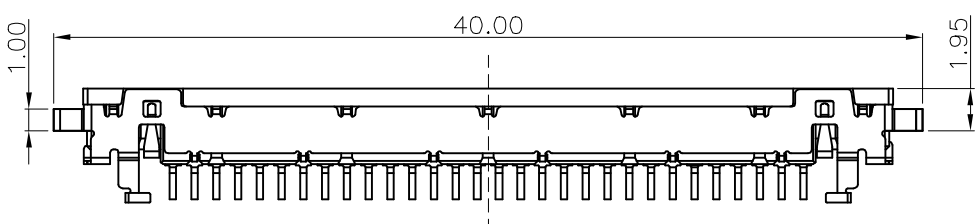

1 F 10066 * ** C * 3 - **
 FPC Type
 Serial number
 F: Gold flash
 T: Matte Tin flash
 PIN NO.
 HF: No Halogen
 3: Without mylar & Reel packing
 0: Natural
 1: BLACK

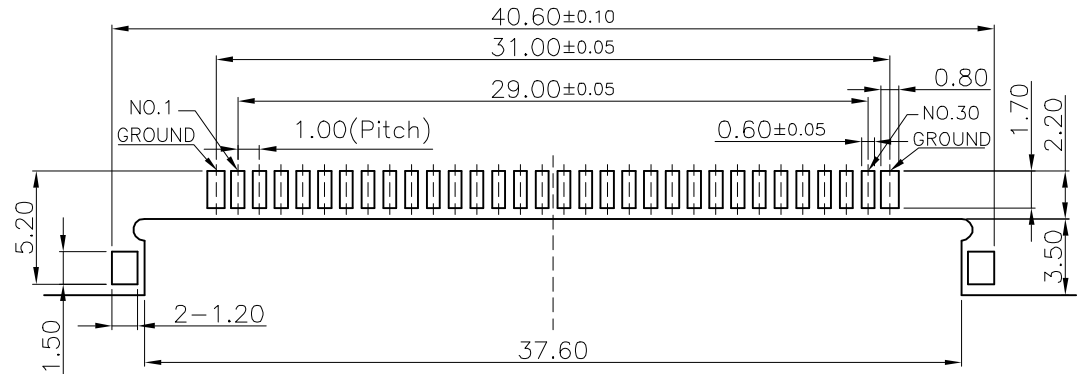

RECOMMEND PCB LAYOUT
 DEFAULT TOL:±0.05

此文件为双方检验的唯一标准
 This document is the only standard for inspection by both parties.

GENERAL TOLERANCE		DRAWN	JON XIA	12/04'19	SCALE	PART NO.	1F10066F30C13-HF
X.±0.30	x.*±3.0'	CHECKED	SHENGJIE CHU	12/04'19	1/1	TITLE	1.0 Pitch H=1.45 Auto-Lock FPC (Offset Type)
.X±0.25	.x'±2.0'	APPROVED	CUNFA LAI	12/04'19	UNITS	mm	CUSTOMER DRAWING
.XX±0.20		File NO.	F10066F01S				
.XXX±0.10		REV.	蘇州祥龍嘉業電子科技股份有限公司 Goldenconn Electronic Technology Co.,LTD				
SHEET	1/3	Q'TY	1	A			

REV.	ECN.NO.	MODIFY.CONTENT	DATE
A		FIRST VERSION	12/04' 19

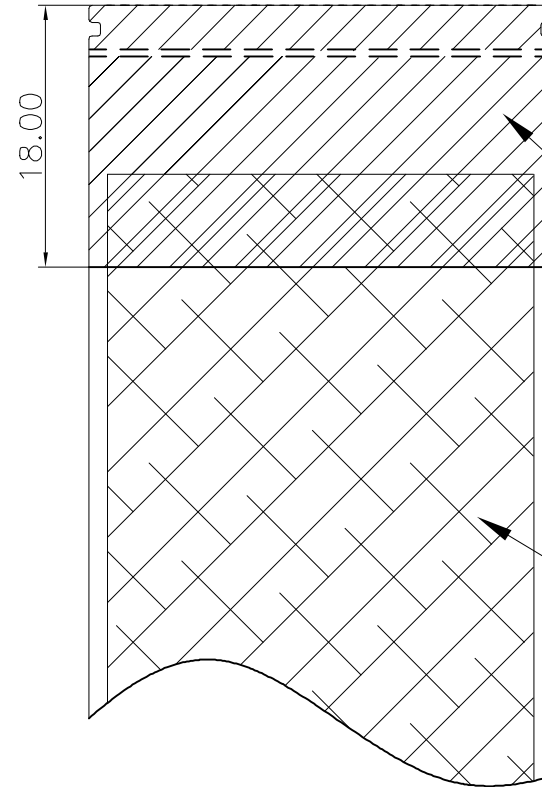
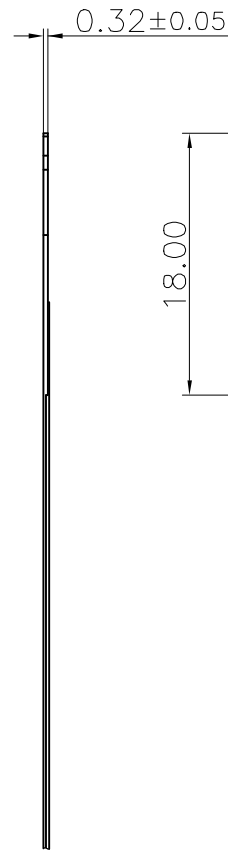
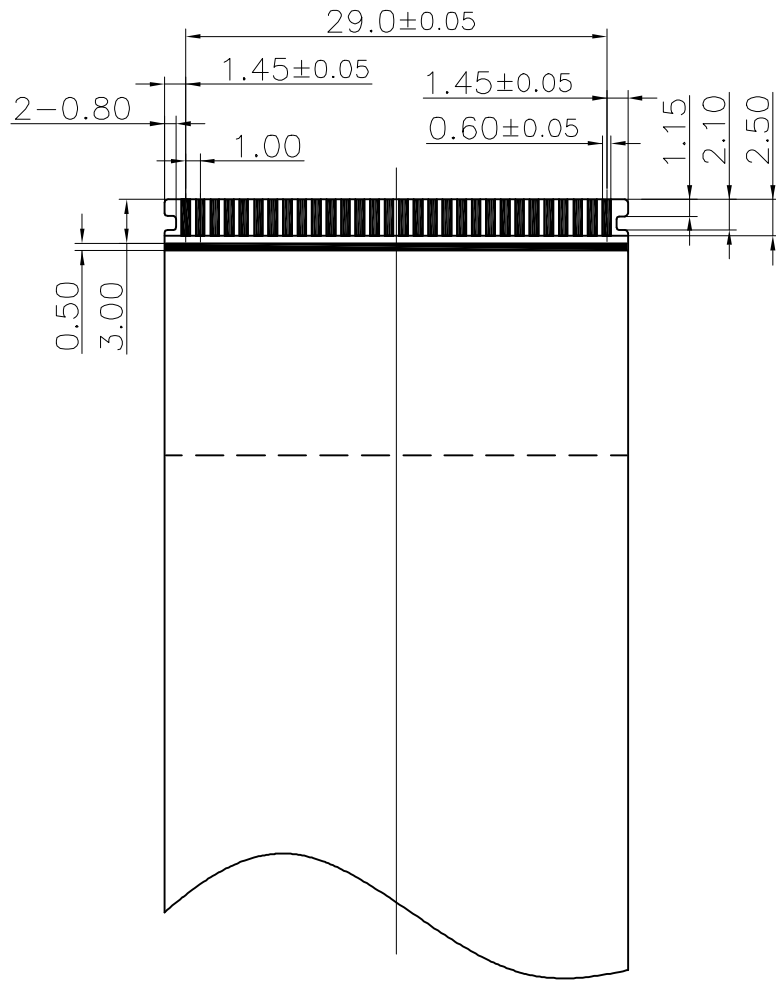

Reinforcing Plate:
Metal Aluminum Foil

Electric Conduction
Aluminum Foil

RECOMMENDED FFC DIMENSION

GENERAL TOLERANCE		DRAWN	JON XIA	12/04'19	SCALE	PART NO.	1F10066F30C13-HF
X.±0.30	x.±3.0°	CHECKED	SHENGJIE CHU	12/04'19	1/1	TITLE	1.0 Pitch H=1.45 Auto-Lock FPC
.X±0.25	.x±2.0°	APPROVED	CUNFA LAI	12/04'19	UNITS	mm	CUSTOMER DRAWING
.XX±0.20		File NO.	F10066F01S				
.XXX±0.10		REV.	蘇州祥龍嘉榮電子科技股份有限公司				
SHEET	2/3	Q'TY	1	A	Goldenconn Electronic Technology Co.,LTD		

REV.	ECN.NO.	MODIFY.CONTENT	DATE
A		FIRST VERSION	12/04' 19

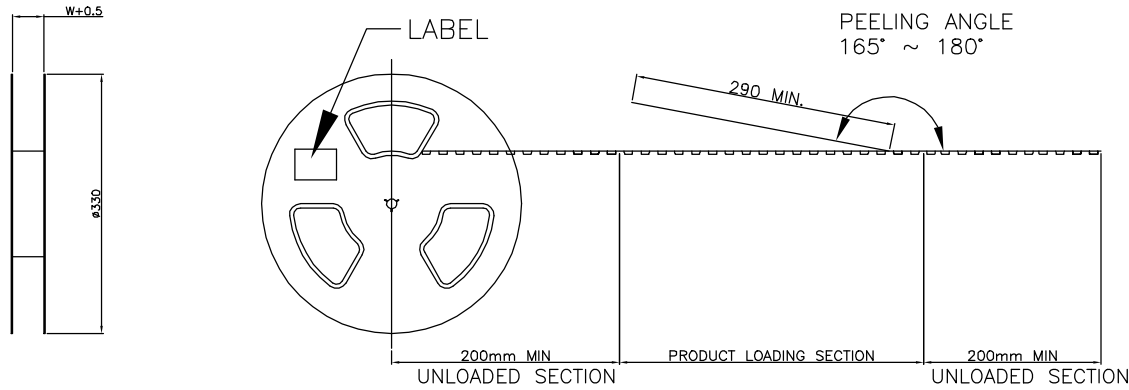

NOTES :

- MATERIAL :
COVER TAPE : P.S T=0.05mm
CARRIER TAPE : P.S T=0.35mm
CARTON: CORRUGATED FIBER
- DIMENSION :
REEL : SEE DRAWING
SHIPPING BOX: 350X350X300mm
- QUANTITY : SEE TABLE
- PEELING RESISTANCE : 10gf~130gf
- PEELING SPEED : 300mm/MINUTES

USER DIRECTION OF UNREELING

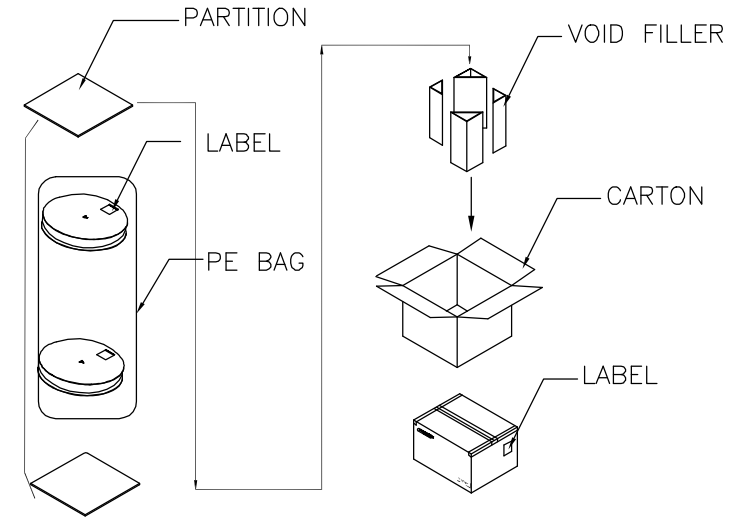
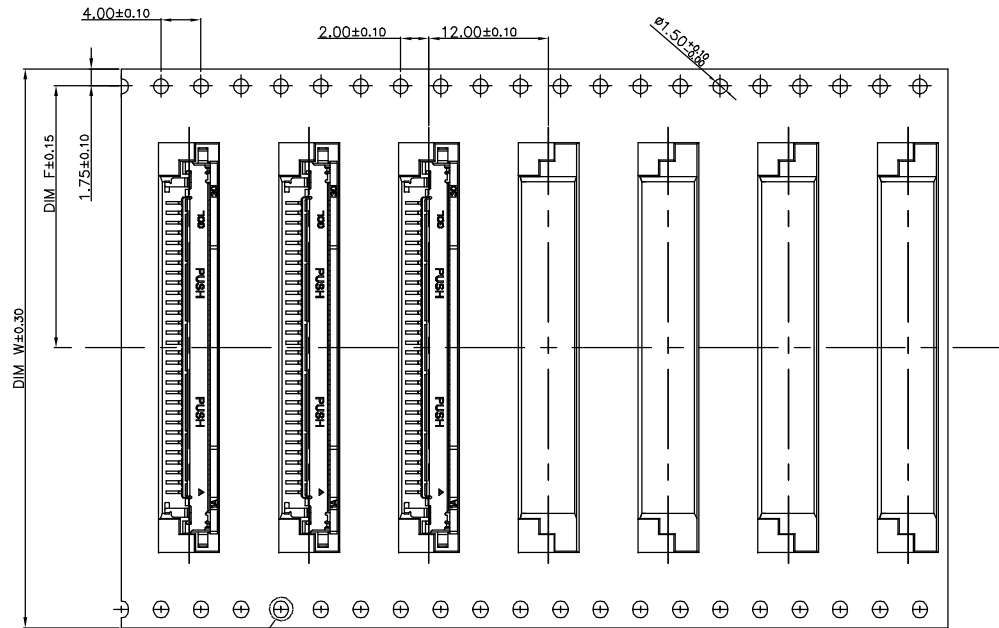
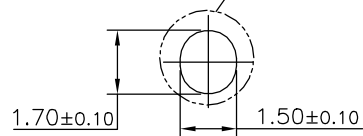

TABLE OF DIM.

POS.	PCS/REEL	BOX/REEL	DIM W	DIM F
30	1500	6000	56	26.20



GENERAL TOLERANCE		DRAWN	JON XIA	12/04'19	SCALE	PART NO.	1F10066F30C13-HF
X.±0.30	x.°±3°	CHECKED	SHENGJIE CHU	12/04'19	1/1	TITLE	1.0 Pitch H=1.45 Auto-Lock FPC
.X±0.25	.x°± 2°	APPROVED	CUNFA LAI	12/04'19	UNITS	mm	CUSTOMER DRAWING
.XX±0.20		File NO.	F10066F01S				
.XXX±0.10		REV.					
SHEET	3/3	Q'TY	1	A	蘇州祥龍嘉業電子科技股份有限公司 Goldenconn Electronic Technology Co.,LTD		